



# BulletCam

Wired security IP camera



NDA  
Compliant

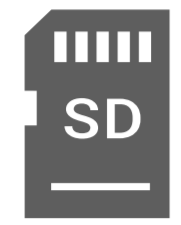

True  
WDR

IP65

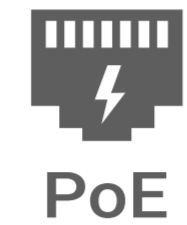

## Product versions

### BulletCam (5 Mp/2.8 mm)

Wired security IP camera with up to 2,880 × 1,620 px resolution and 100°–110° viewing angle

### BulletCam (8 Mp/2.8 mm)

Wired security IP camera with up to 3,840 × 2,160 px resolution and 100°–110° viewing angle

### BulletCam (5 Mp/4 mm)

Wired security IP camera with up to 2,880 × 1,620 px resolution and 75°–85° viewing angle

### BulletCam (8 Mp/4 mm)

Wired security IP camera with up to 3,840 × 2,160 px resolution and 75°–85° viewing angle

## How it works

BulletCam operates seamlessly by utilizing Ajax Cloud for transmitting system events, while the proprietary JetSparrow technology ensures fast peer-to-peer transmission of video data. With AI-analysis capabilities, BulletCam can detect and recognize object types, such as humans, vehicles, and pets. This allows the surveillance system to record only relevant events and use less storage. To make surveillance precisely selective, it is possible to enable cameras only when the system is armed.

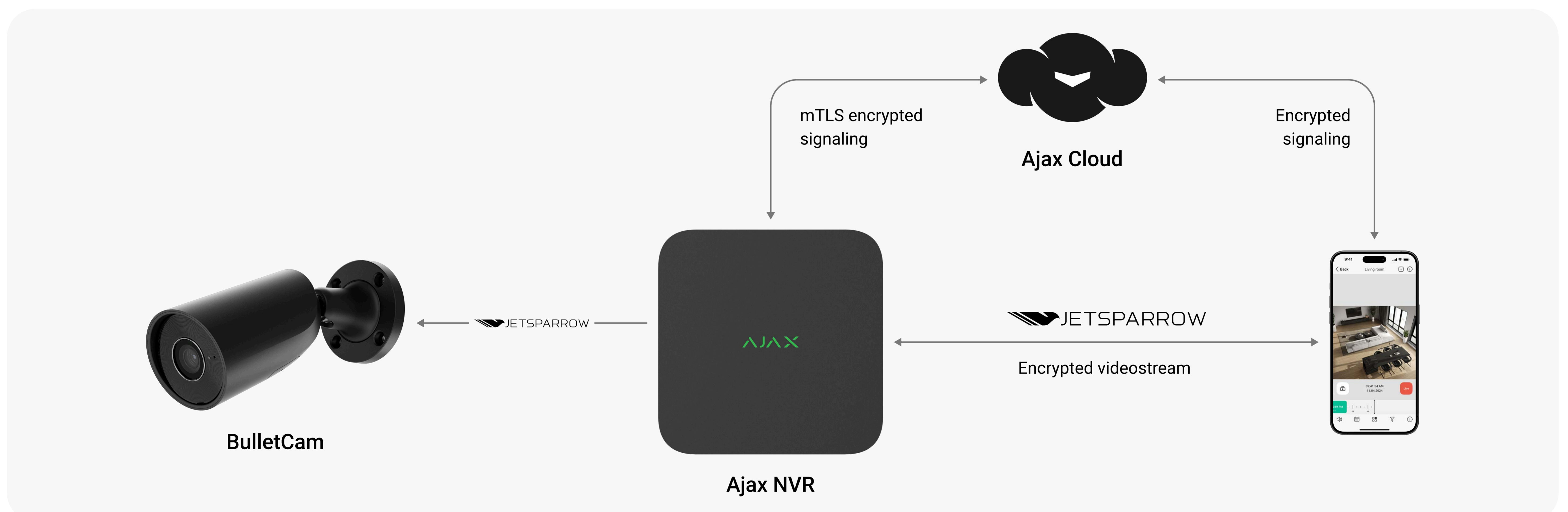

BulletCam can operate without Ajax NVR, saving the archive on the SD card (if installed)

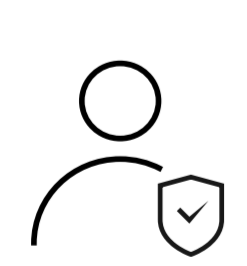

## Uncompromising security and privacy

- Passwordless camera authentication with mTLS handshake
- Video stream with TLS encryption
- Real-time privacy control via the apps
- Account security with passcodes, biometrics, and two-factor authentication
- Session control for added protection
- Owner-only access to media data recorded on the hard drive
- Accelerometer to notify of impacts or dismantling (in future releases)
- Components only from white-listed vendors in NDA

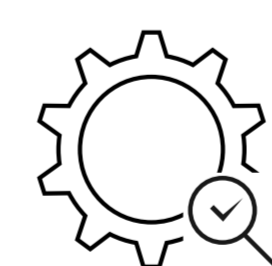

## Seamless user experience

- Objects AI recognition: humans, vehicles, pets<sup>1</sup>
- High-resolution visual verification for alarms with video scenarios<sup>1</sup>
- Easy transition from notifications feed to on-site video recordings<sup>1</sup>
- Cameras synchronization with security modes
- Real-time oversight with a customizable video wall
- TrueWDR for exceptional image quality

## Smooth archive navigation

- JetSparrow peer-to-peer streaming
- Instant live view
- Fast archive navigation with filters and calendar
- Dual streaming for instant preview
- Video clip export in a few clicks

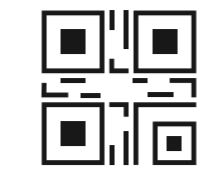

## Easy installation and maintenance

- Connection via QR code
- Configuration via Ajax apps
- Adjustable motion detection zones available in the apps
- Real-time supervision with health checks

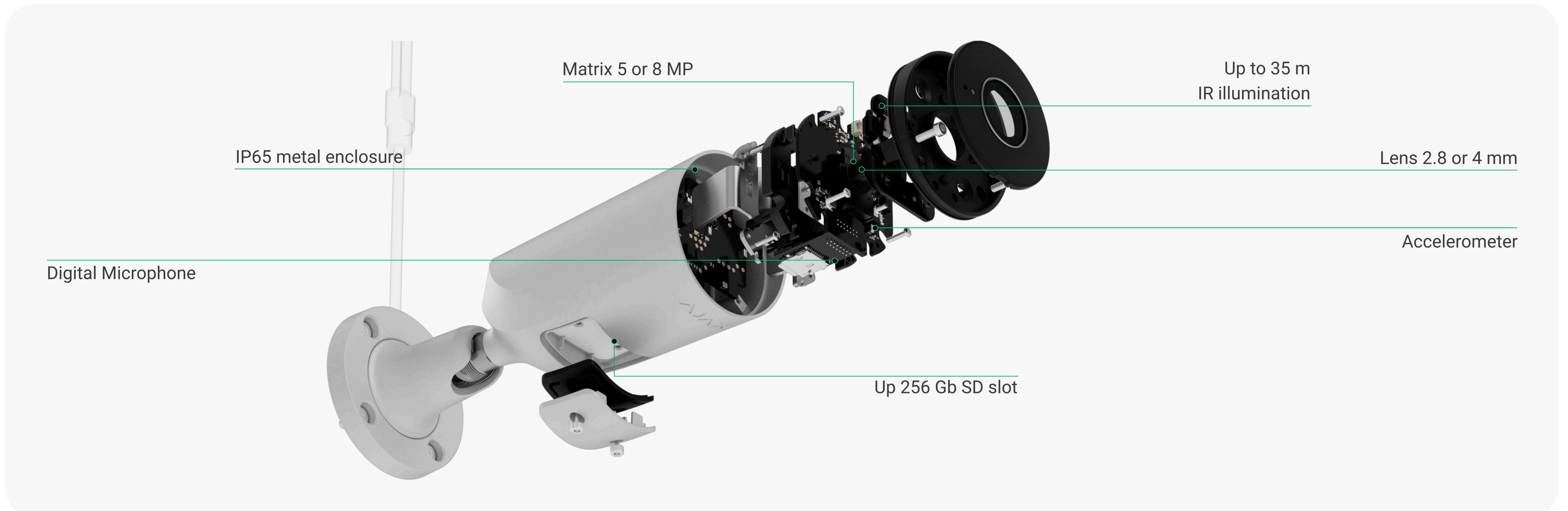

Superior, Fibra, and Baseline product lines are mutually compatible. This opens up numerous possibilities for building systems of any configuration.

<b>Features</b>  <b>Resolution</b> 5 MP Model: Up to 2,880 × 1,620 px @ 25 fps (3K UHD) 8 MP Model: Up to 3,840 × 2,160 px @ 20 fps (4K UHD)  <b>Lens</b> 2.8 mm: 100°–110° Viewing Angle 4 mm: 75°–85° Viewing Angle  <b>Day/Night Switch</b> Automatic  <b>Image processing</b> True WDR (hardware and software)  <b>Video Compression</b> H.265, H.264  <b>Bitrate</b> 100 Mbps full-duplex  <b>Simultaneous Live View</b> Up to 5 Channels  <b>User Access</b> Up to 200 Users  <b>Alarm Trigger</b> Motion Detection, AI-recognition, Detector alarm, Automation scenarios	<b>Compatibility</b>  <b>Hubs</b> All Ajax hubs (up to 200 cameras in one Ajax system)  <b>Video recorders</b> NVR	<b>Power supply</b>  <b>Power supply unit</b> 12 V ± 20% ⚡, 1 A Up to 15 W of mains power consumption  <b>Ethernet port</b> PoE Standard 802.3at, Class 3
	<b>Enclosure</b>  <b>Dimensions</b> 197.5 × 76 × 76 mm  <b>Weight</b> 550 g  <b>Colors</b> Black White  <b>Operating temperature range</b> from -30 °C to +60 °C from -22 °F to +140 °F  <b>Operating humidity</b> up to 95%	<b>Compliance</b>  CE RoHS NDAA  <b>Complete set</b>  BulletCam Installation template Installation kit Quick start guide

<sup>1</sup> Requires an SD-card installed or connection to NVR with a hard drive



For detailed information, scan the QR code or follow the link:

[ajax.systems/support/devices/bulletcam/](https://ajax.systems/support/devices/bulletcam/)

- ✉ support@ajax.systems
- 📧 @AjaxSystemsSupport\_Bot
- 🌐 ajax.systems